

# PWB-320 / PWB-323

## Project Wall Boxes



(Shown with optional equipment installed)



Optional International internal socket bracket for use with 45mm sockets

# FSR

## Metal Products Group

### DESCRIPTION

These economical, large opening wall boxes are designed to fit in 16" on-center stud bays. Their design simplifies audio video and IT installations by providing space for routing cables, AC power connections, and digital media products. The PWB-320 is for 4" stud walls and has up to 2" KO's. The PWB-323 is for 3" stud walls and has up to 1 1/4" KO's.

All boxes come standard with 8 flush cable-tie mounts, 6 Triple-Play™ mounting solutions for AC/AV/IT, 6 IPS mounting openings, a grounding screw, steel stud mounting brackets and hardware for new or old-work wood or steel stud walls.

The PWB-32x-TRK kit includes all of the above features plus a powder coated trim ring for dressing the dry-wall opening. This rounded trim ring provides a generous 7/8" overlap.

The PWB-32x-ESK kit includes the above TRK features and an internal shelving system. Two adjustable shelves include a hole pattern that allows for any screw spacing from 3/8" to 1 1/4" including multiple VESA 100 hole pattern locations.

The PWB-320-CV is an optional powder coated cover with rounded cable exits. The vented cover mounts to the trim ring with four tool-less snap fasteners to allow quick access to the equipment inside.

There are optional internal AC brackets available with 2 or 3 Decora SpikeShield™ 15-amp surge protected receptacles. See ordering table for model numbers. Need to keep your equipment cool while in the wall, our optional PWB-320-Fan will do just that. The PWB-320-FAN is a variable speed temperature controlled fan option for the PWB-320 and 320XL wall box. Whisper quiet, the fan produces a 24dBA SPL at an 80-watt heat load. It is designed to maintain an internal box temperature below 104°F with a 100 watt thermal load keeping internal equipment at a safe temperature.

### APPLICATIONS

- Digital Signage
- Hospitals
- Conference Centers
- Schools
- Airports
- Command Centers
- Electronic Billboards
- Museums
- Arenas

### FEATURES

- Mounts to wood or steel studs, 16" centers
- No extra parts needed for New or Old work installations
- Can be ordered individually or in 3 different kits and in 2 depths
- Optional painted cover with cable exits and tool-less fasteners
- Up to 2" KO on PWB-320
- Up to 1-1/4" KO on PWB-323
- Six IPS mounting openings
- Eight Flush cable-tie mounts
- Six Triple Play Mounting Solution openings per box
- Optional Cover and Trim Ring available separately
- Optional (2) adjustable component shelves with position lock
- Optional AC power brackets with 15-amp surge protected receptacles
- Optional thermostat controlled variable speed fan
- Optional International internal socket bracket for use with 45mm sockets

### FSR Inc.

244 Bergen Boulevard, Woodland Park, NJ 07424

Phone: 973.998.2300 · Fax: 973.785.4207

Order Desk: 1-800-332-FSR1

Web: fsrinc.com · E-mail: sales@fsrinc.com LIT1651E

# FEATURES / DETAILS

## TRIPLE PLAY KNOCKOUT SYSTEM

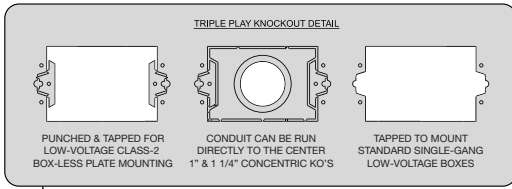

## VESA 100 MOUNTING PATTERN

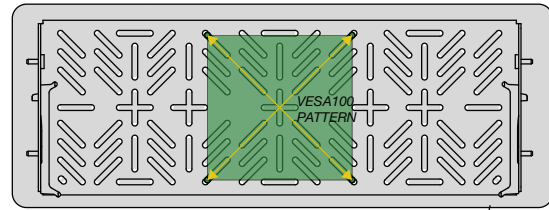

FSR PWB boxes are punched in six locations with FSR's Triple Play Mounting Solution which provides three different options for mounting conduit, cabling, plates, and back boxes to our wall boxes.

FSR's patent-pending Triple Play Mounting Solutions:

1. Conduit can be run directly to the Center 1" & 1 1/4" Concentric Knock Out
2. Punched & Tapped for Low-voltage Class-2 box-less plate mounting
3. Tapped to mount standard single gang low-voltage boxes

## SHELVING FEATURES

Shelving location and depth can be adjusted as well as mounted in horizontal or vertical orientation

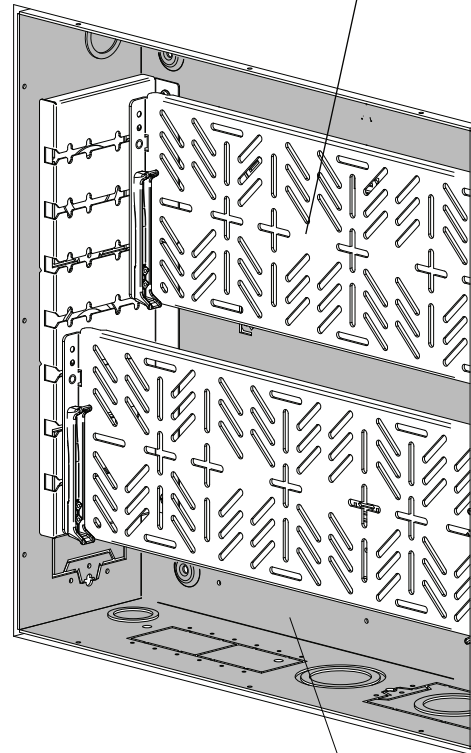
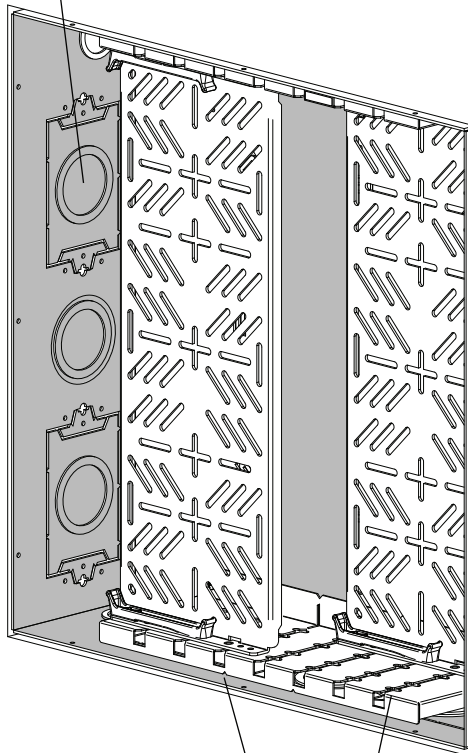

### CUT TABS

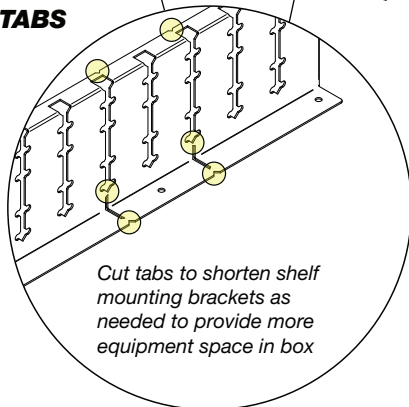

### TIE WRAP TABS LOCATED ON BACK OF BOX

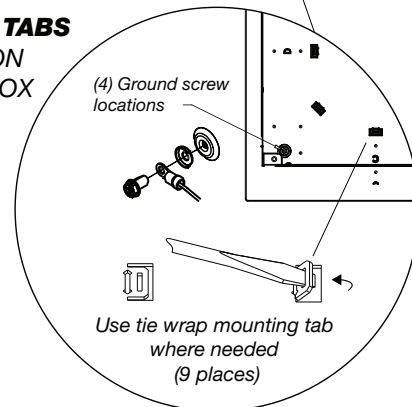

Drawings are available on the FSR website.

# DIMENSIONS / DETAILS

## BOX SIDE DETAILS

LETTERS (A,B,C,D) DENOTE THE SIDES OF THE BOX FOR REFERENCE

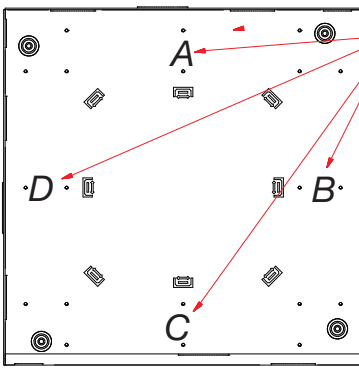

SIDE LOCATION REFERENCE LETTERS

Drawings are available on the FSR website.

Interior Shown.

## PWB-320

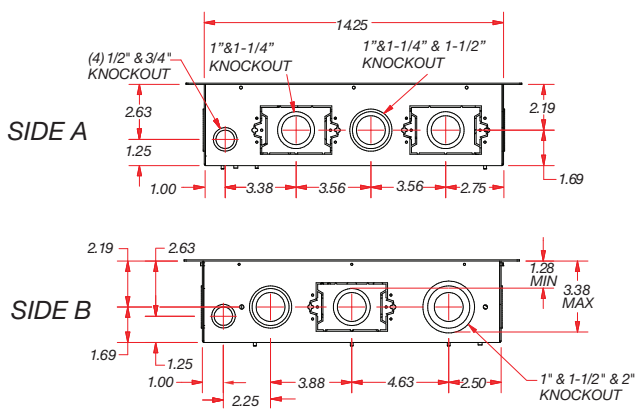

## PWB-323

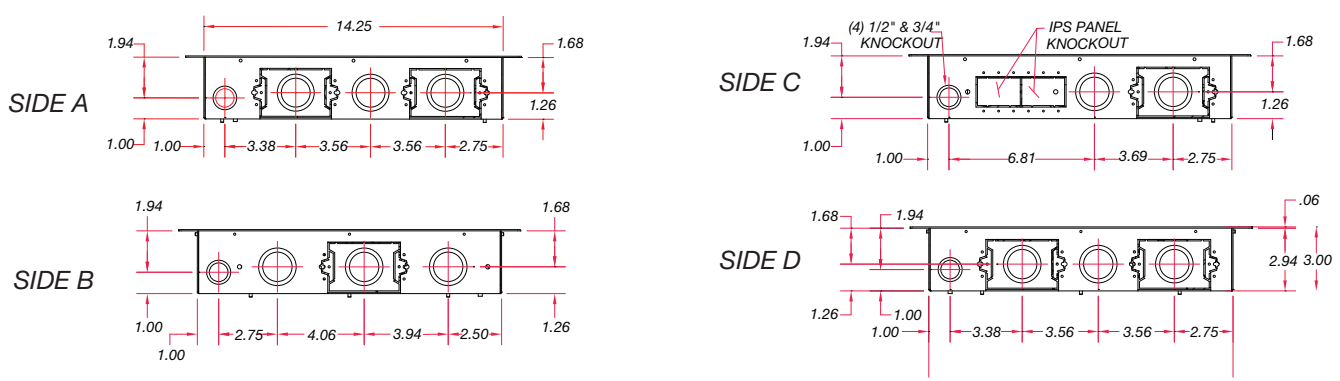

## PWB-320-BX

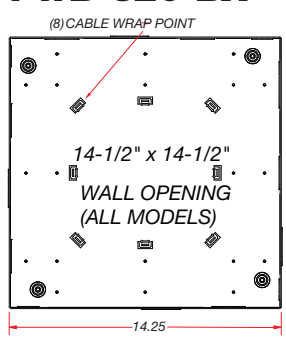

Interior Shown.

## PWB-320-TRK

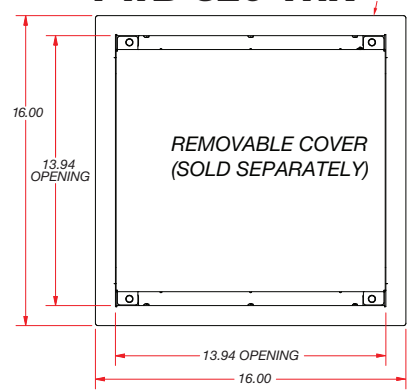

## PWB-320-ESK

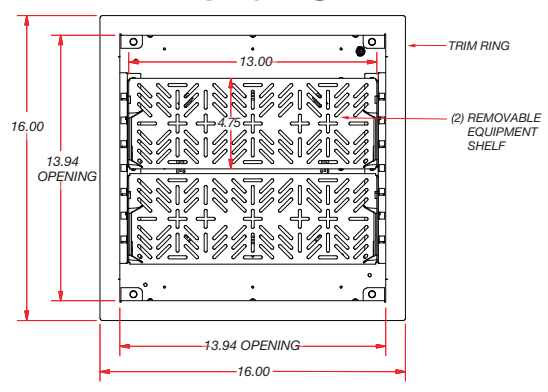

# AC POWER BRACKETS

## PWB-320-AC2

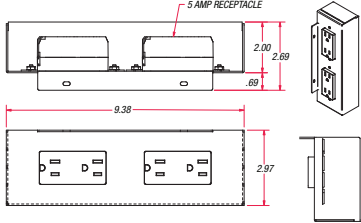

## PWB-323-AC2

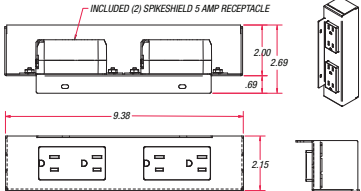

## PWB-320-AC3

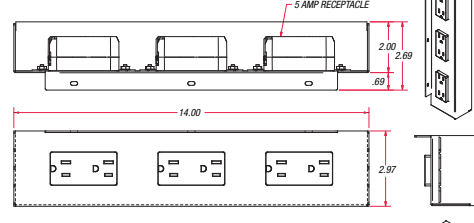

## PWB-323-AC3

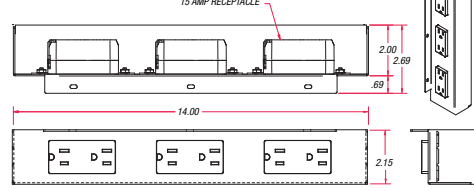

## International Brackets for use with PWB-323

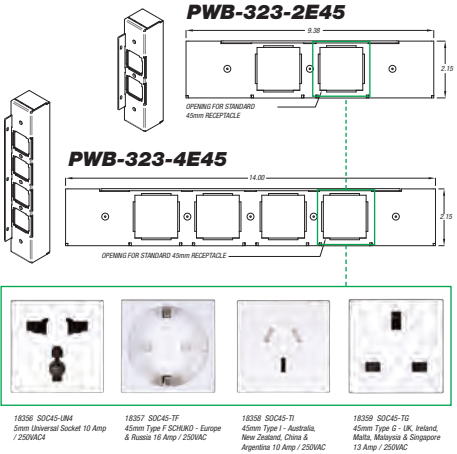

# AC POWER BRACKET LOCATIONS

## PWB-320-AC2

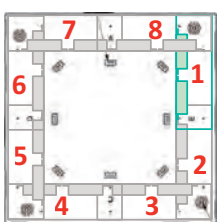

## PWB-320-AC3

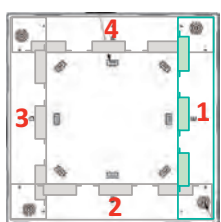

## PWB-323-AC2

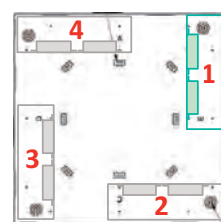

## PWB-323-AC3



PWB-320/323 AC Power Bracket total number of available positions shown for each AC Power Bracket style.

# PWB COOLING FAN

## PWB-320-FAN

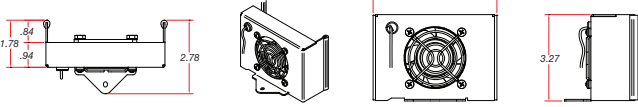

# ORDERING TABLE

Item #	Model #	Description
18004	PWB-320-BX	Full size wall box with mounting hardware
18005	PWB-320-TRK	Kit consisting of full size box with finished Trim Ring
18006	PWB-320-ESK	Kit consisting of full size box, with 2 equipment shelves and finished trim ring
18009	PWB-320-AC2	Internal AC bracket with 2 Decora SpikeShield™ 15 amp Receptacles
18010	PWB-320-AC3	Internal AC bracket with 3 Decora SpikeShield™ 15 amp Receptacles
18007	PWB-320-TR	Decorative finished trim ring only (fits PWB-320 and PWB-323)
18008	PWB-320-CV	Decorative Cover only (fits PWB-320 and PWB-323)
18011	PWB-323-BX	Full size wall box with mounting hardware
18012	PWB-323-TRK	Kit consisting of full size box with finished Trim Ring
18013	PWB-323-ESK	Kit consisting of full size box, with 2 equipment shelves and finished trim ring
18014	PWB-323-AC2	Internal AC bracket with 2 Decora SpikeShield™ 15 amp Receptacles
18015	PWB-323-AC3	Internal AC bracket with 3 Decora SpikeShield™ 15 amp Receptacles
18055	PWB-320-SMK	Shelf Kit - 2 Shelves and Side Brackets
18056	PWB-323-SMK	Shelf Kit - 2 Shelves and Side Brackets
18366	PWB-320-FAN	Fan option for use with PWB-320 and PWB-320XL boxes
18593	PWB-323-4E45	Internal 45mm Bracket with 4 - 45mm Socket Openings
18594	PWB-323-2E45	Internal 45mm Bracket with 2 - 45mm Socket Openings

Specifications are subject to change without notice.



Drawings are available on the FSR website.

## FSR Inc.

244 Bergen Boulevard, Woodland Park, NJ 07424  
 Phone: 973.998.2300 · Fax: 973.785.4207  
 Order Desk: 1-800-332-FSR1  
 Web: fsrinc.com · E-mail: sales@fsrinc.com