

RFL Series D Raised Access Floor Boxes

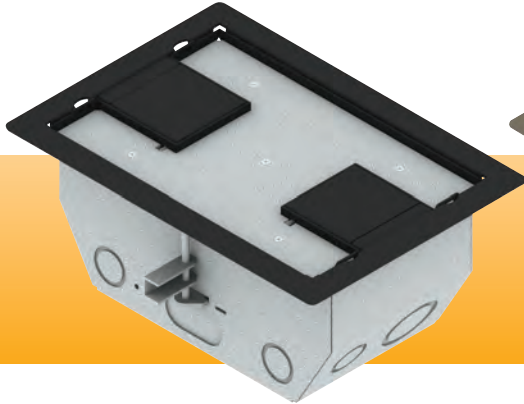

RFL4.5-D2G-BLKDD



RFL4.5-D1G-SLCLY

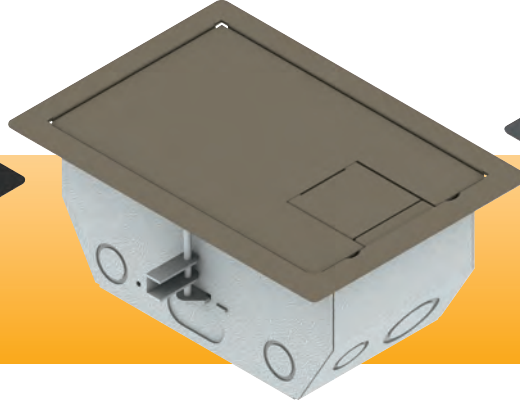

RFL3-D1G-GRY

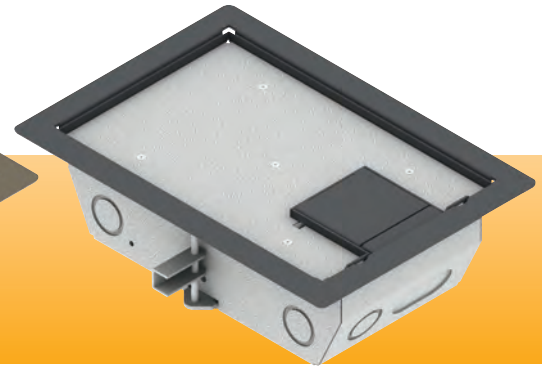

FSR

Metal Products Group

RFL Series D

DESCRIPTION

The RFL Series D Raised Access Floor Boxes are designed for flexibility, durability and style. These rugged units safely handle the rigors of high traffic floor environments. There are three cover styles to choose from: Single door carpet trim cover, dual door carpet trim cover or a single door solid cover.

All cover styles are available in three colors with custom colors available on request (Consult factory).

All Series D models feature all steel construction for durability and are designed to install in a 6½" X 9¼" opening in the floor. They are available in either 4⅛" or 3¼" box depths.

The RFL4.5-D2G is a 4⅛" deep floor box with two standard double gang openings on opposite sides of the box. Either or both of the compartments may be used for power or data.

The RFL4.5-D1G is a 4⅛" deep floor box with two standard single gang openings on opposite sides of the box and 1 single gang opening on the bottom for data. The data plate insert is removable for added room in the box.

The RFL3-D1G is a 3¼" deep floor box with 2 standard single gang openings on opposite sides of the box. Either or both of the compartments may be used for power or data.

Specifications are subject to change without notice.

FEATURES

The RFL Series D features:

- Patented epoxy wrinkle powder finish, available in 3 colors
- Choice of three cover styles; solid, single-door and dual-door
- 14-gauge steel construction
- Cover thickness ⅜"
- Oversize cable door(s)
- Standard electrical plate openings on all models
- Superior mounting clamp design to handle a wide variety of floor thicknesses
- Listed by UL to meet US and Canadian safety standards
- Large multi-compartment boxes for power, audio, video, data and more!
- Multiple knockouts in a variety of sizes
- Choice of two box depths
- Choice of two gang layout styles

Architectural Note: The carpet rim and cable exit door are available standard in gray, black, or clay. Custom finishes are also available as an option. Optional 1" x 2" KO grommet FSR part #13342.

FSR Inc.

244 Bergen Boulevard, Woodland Park, NJ 07424
Phone: 973.785.4347 · Fax: 973.785.4207
Web: www.fsrinc.com · E-mail: sales@fsrinc.com
Order Desk: 1-800-332-FSR1

LIT1115C

RFL-D Cover Dimensions

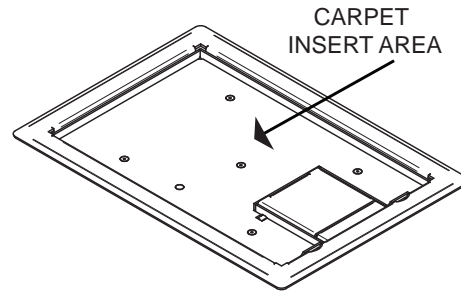
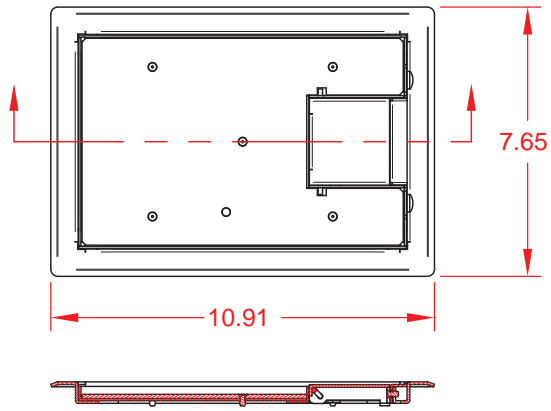

SINGLE DOOR

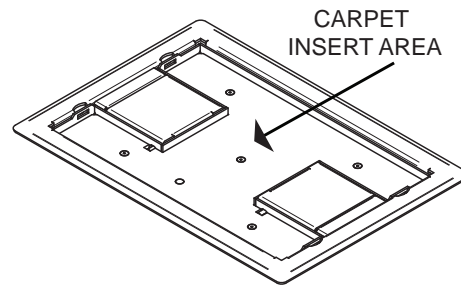
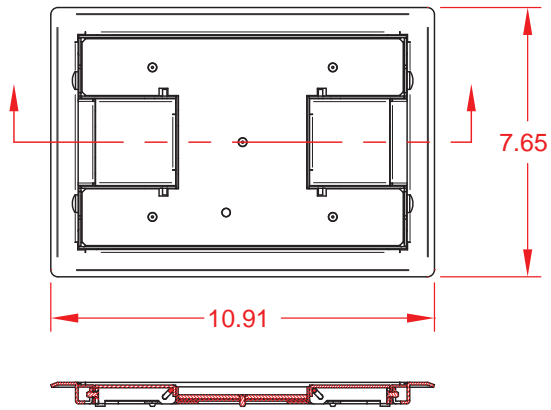

DUAL DOOR

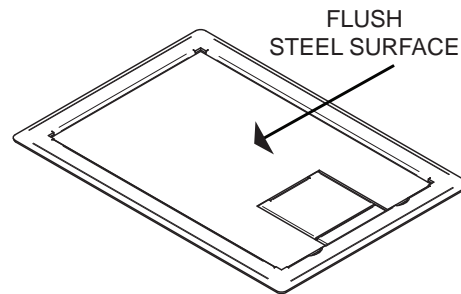
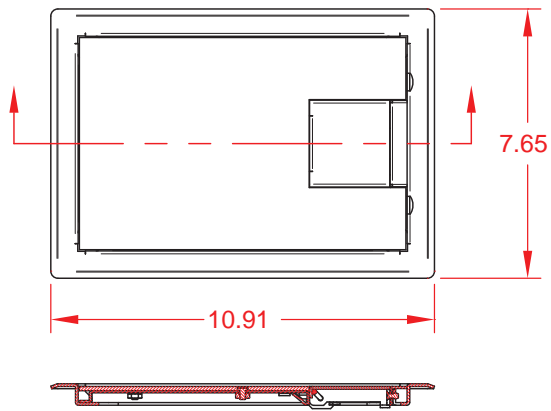

SOLID COVER

RFL-D General Dimensions

RFL3-D1G

Box Volume (Less Panels) 110 cu in.
 Device Compartment Volume 24 cu in.
 Brackets Includes - 2 Single Gang
 Number and Size of Knockouts
 2 - .5" on the bottom
 6 - .5" - .75" on the sides
 2 - 1" x 2.5" oval on the sides
 Cover Material - 16/14 ga Steel
 under 11 ga Steel Support
 Support flange Material -
 14 g galvanized Steel
 Max No of Insert Brackets -
 2-single gang (Provided)

9.75 x 6.50
 FLOOR HOLE SIZE

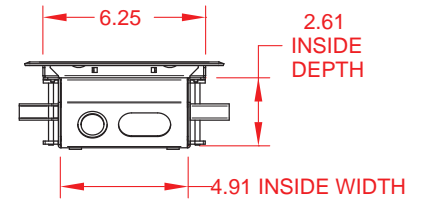
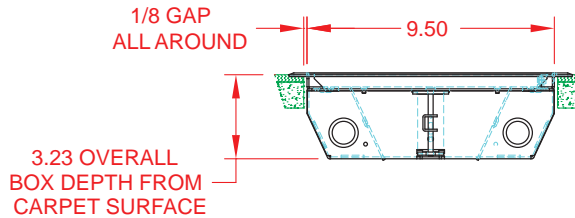
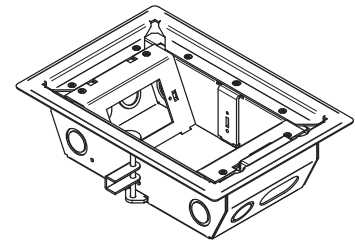
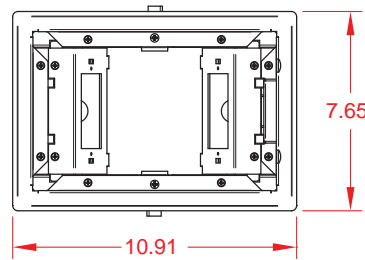

RFL4.5-D1G

Box Volume (Less Panels) 169 cu in.
 Device Compartment Volume 39 cu in.
 Brackets Includes -
 3 Single Gang, 2 power and 1 Data
 Number and Size of Knockouts
 2 - .5" on the bottom
 6 - .5" - .75" on the sides
 2 - 1" - 1.25" on the sides
 3 - 1" x 2" oval on the sides
 Cover Material - 16/14 ga Steel
 under 11 ga Steel Support
 Support flange Material -
 14 g galvanized Steel
 Max No of Insert Brackets -
 3-single gang
 (Provided)

9.75 x 6.50
 FLOOR HOLE SIZE

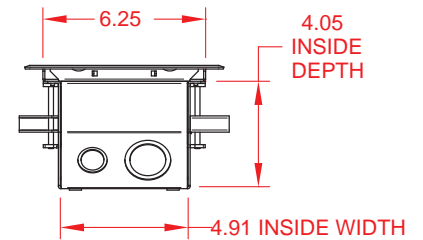
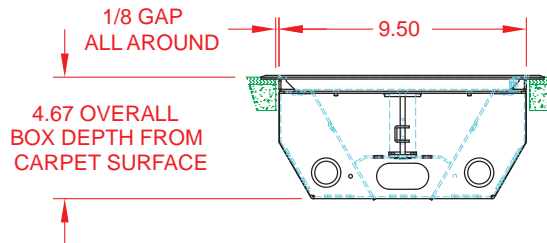
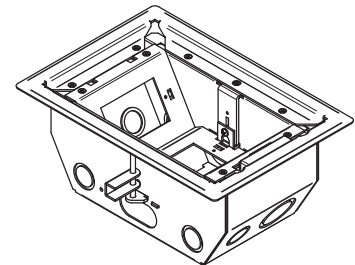
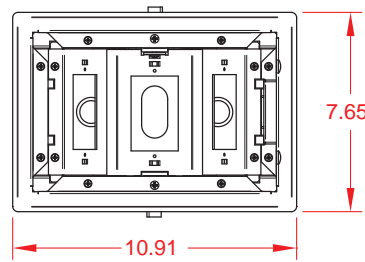

RFL4.5-D2G

Box Volume (Less Panels) 169 cu in.
 Device Compartment Volume 39 cu in.
 Brackets Includes - 2 Double Gang
 Number and Size of Knockouts
 2 - .5" on the bottom
 6 - .5" - .75" on the sides
 2 - 1" - 1.25" on the sides
 3 - 1" x 2" oval on the sides
 Cover Material - 16/14 ga Steel
 under 11 ga Steel Support
 Support flange Material -
 14 g galvanized Steel
 Max No of Insert Brackets -
 2-double gang
 (Provided)

9.75 x 6.50
 FLOOR HOLE SIZE

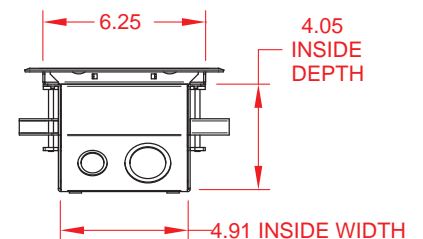
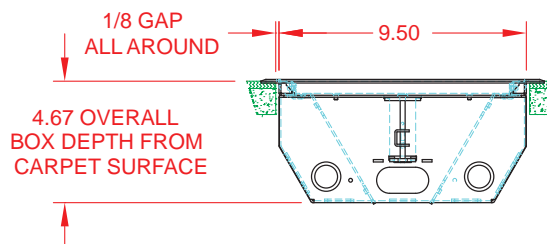
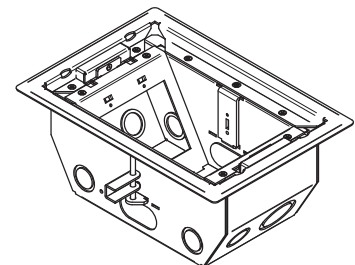
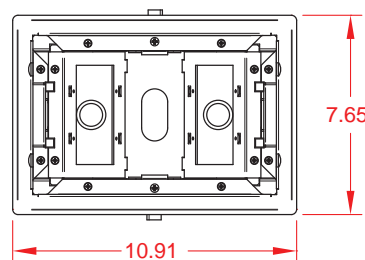

RFL SERIES D ORDERING INFORMATION

ITEM #	PART#	DESCRIPTION
Carpet Trim Cover with Single Door 3" Deep with Two 1-Gang Openings		
16100	RFL3-D1G-GRY	3" deep back box with 2, 1-gang openings - Gray Trim
16106	RFL3-D1G-BLK	3" deep back box with 2, 1-gang openings - Black Trim
16112	RFL3-D1G-CLY	3" deep back box with 2, 1-gang openings - Clay Trim
Carpet Trim Cover with Single Door 4.5" Deep with Three 1-Gang Openings (One for data use only)		
16102	RFL4.5-D1G-GRY	4.5" deep back box with 3, 1-gang openings - Gray Trim
16108	RFL4.5-D1G-BLK	4.5" deep back box with 3, 1-gang openings - Black Trim
16114	RFL4.5-D1G-CLY	4.5" deep back box with 3, 1-gang openings - Clay Trim
Carpet Trim Cover with Single Door 4.5" Deep with Two 2-Gang Openings		
16103	RFL4.5-D2G-GRY	4.5" deep back box with 2, 2-gang openings - Gray Trim
16109	RFL4.5-D2G-BLK	4.5" deep back box with 2, 2-gang openings - Black Trim
16115	RFL4.5-D2G-CLY	4.5" deep back box with 2, 2-gang openings - Clay Trim
Carpet Trim Cover with Dual Door 3" Deep with Two 1-Gang Openings		
16118	RFL3-D1G-GRYDD	3" deep back box with 2, 1-gang openings - Gray Trim
16124	RFL3-D1G-BLKDD	3" deep back box with 2, 1-gang openings - Black Trim
16130	RFL3-D1G-CLYDD	3" deep back box with 2, 1-gang openings - Clay Trim
Carpet Trim Cover with Dual Door 4.5" Deep with Three 1-Gang Openings (One for data use only)		
16120	RFL4.5-D1G-GRYDD	4.5" deep back box with 3, 1-gang openings - Gray Trim
16126	RFL4.5-D1G-BLKDD	4.5" deep back box with 3, 1-gang openings - Black Trim
16132	RFL4.5-D1G-CLYDD	4.5" deep back box with 3, 1-gang openings - Clay Trim
Carpet Trim Cover with Dual Door 4.5" Deep with Two 2-Gang Openings		
16121	RFL4.5-D2G-GRYDD	4.5" deep back box with 2, 2-gang openings - Gray Trim
16127	RFL4.5-D2G-BLKDD	4.5" deep back box with 2, 2-gang openings - Black Trim
16133	RFL4.5-D2G-CLYDD	4.5" deep back box with 2, 2-gang openings - Clay Trim
Solid cover - Single Door 3" Deep with Two 1-Gang Openings		
16136	RFL3-D1G-SLGRY	3" deep back box with 2, 1-gang openings - Gray Trim
16142	RFL3-D1G-SLBLK	3" deep back box with 2, 1-gang openings - Black Trim
16148	RFL3-D1G-SLCLY	3" deep back box with 2, 1-gang openings - Clay Trim
Solid cover - Single Door 4.5" Deep with Three 1-Gang Openings (One for data use only)		
16138	RFL4.5-D1G-SLGRY	4.5" deep back box with 3, 1-gang openings - Gray Trim
16144	RFL4.5-D1G-SLBLK	4.5" deep back box with 3, 1-gang openings - Black Trim
16150	RFL4.5-D1G-SLCLY	4.5" deep back box with 3, 1-gang openings - Clay Trim
Solid cover - Single Door 4.5" Deep with Two 2-Gang Openings		
16139	RFL4.5-D2G-SLGRY	4.5" deep back box with 2, 2-gang openings - Gray Trim
16145	RFL4.5-D2G-SLBLK	4.5" deep back box with 2, 2-gang openings - Black Trim
16151	RFL4.5-D2G-SLCLY	4.5" deep back box with 2, 2-gang openings - Clay Trim

Similar FSR Products

The **RFL Series AV** raised access floor boxes are perfect for applications in raised floors where AV connections and power are required in one box. They are available in a small two gang "D" model and a larger "Q" model to accommodate up to a 4-gang arrangement (requires optional plate) to handle a variety of installation demands. See RFL Series AV spec sheet for details.



RFL-QAV-SLBLK Pictured

The **RFL Series Q** raised access floor boxes are designed for installation applications where higher capacity is required. These large multi-compartment boxes have ample room for power, video, audio, data and more. They are available in two depths, two gang layout styles with removable dividers to isolate power and create different gang arrangements. See RFL Series Q spec sheet for details.

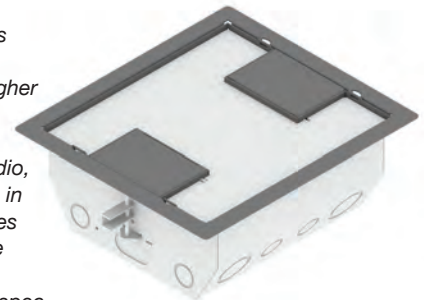

RFL45-Q2G-BLKDD Pictured



Specifications are subject to change without notice.

FSR

244 Bergen Boulevard, Woodland Park, NJ 07424
 Phone: 973.785.4347 · Fax: 973.785.4207
 Web: www.fsrinc.com · E-mail: sales@fsrinc.com