

TAB
SLOT

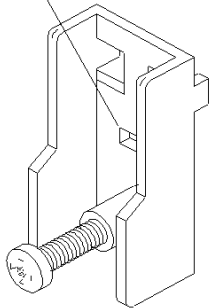

1. INSTALL SCREWS
PROVIDED

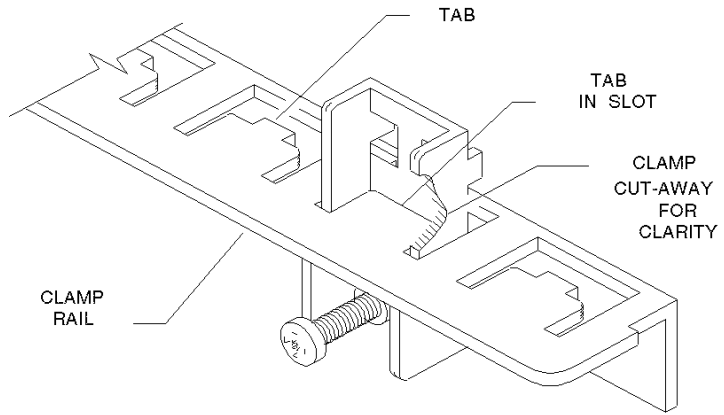

2. INSERT CLAMPS AS NEEDED
INTO
TOP AND BOTTOM CLAMP RAILS

WALL
PLATE

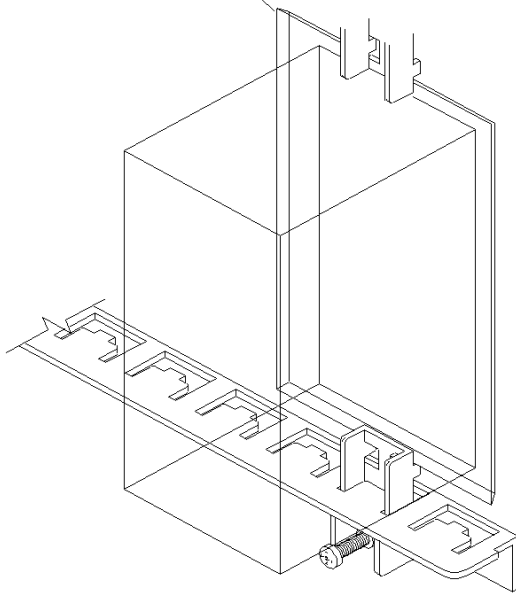

SCALE
0.5:1

3. INSERT WALL PLATES
AND
TIGHTEN SCREWS AS
NECESSARY

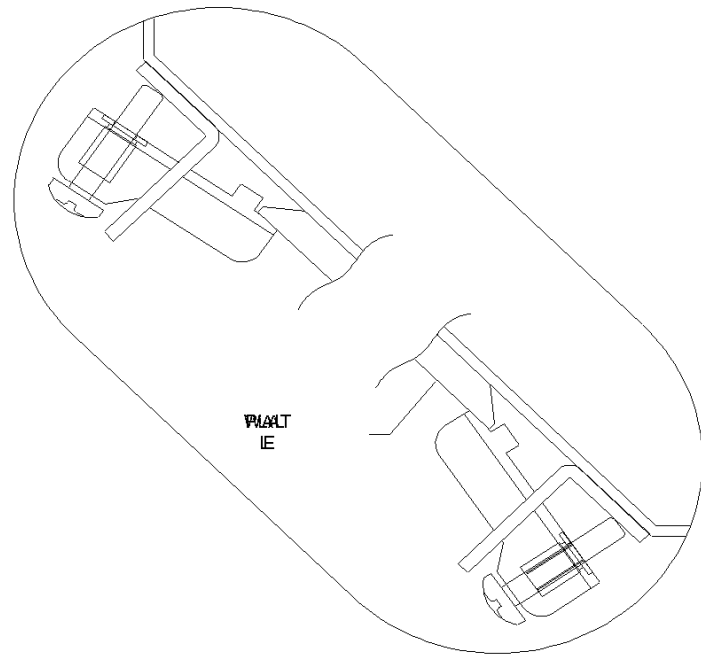

FSR inc.

244 BERGEN BLVD.
WEST PATERSON, NJ 07424
PH.#: (973)785-4347

HOLD-DOWN CLAMP
INSTALLATION INSTRUCTIONS

FILE NAME:
G:\TABLEBOX\CLAMPINS

DATE:
01/20/00

SCALE
1:1

4G/5G/6G TABLE BOXES 1 THRU 4 GANG PLATE SETUPS

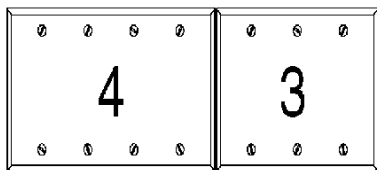
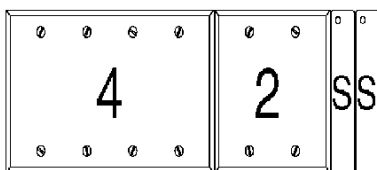
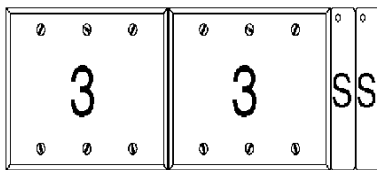
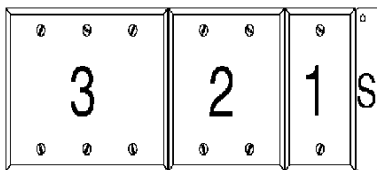
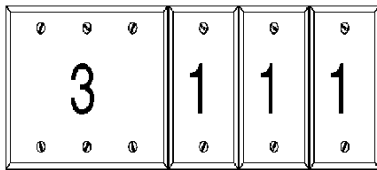
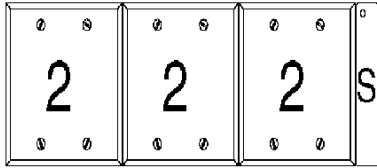
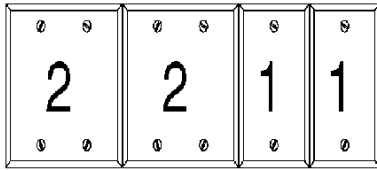

**S
T
A
N
D
A
R
D**

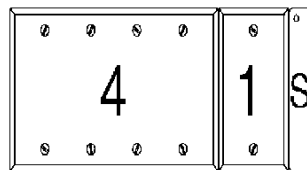
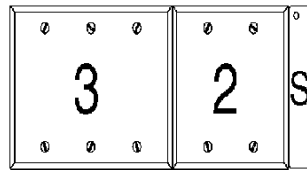
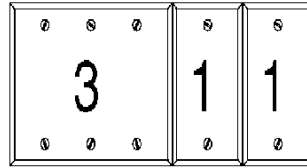
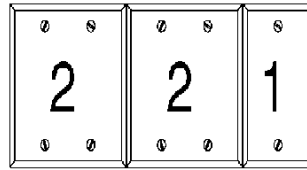

**S
E
T
—
U
P
S**

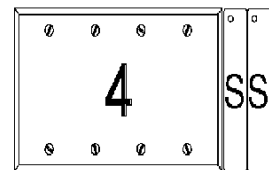
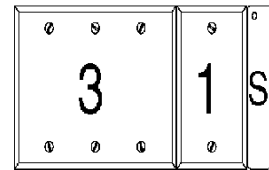
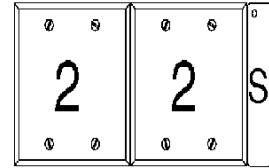
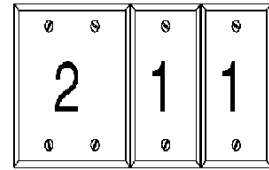

5-GANG

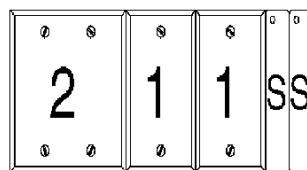
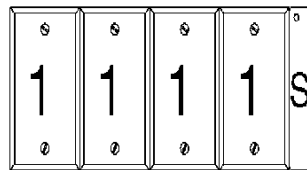

4-GANG

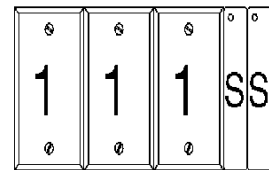

6-GANG

**ADDITIONAL
SET-UPS**

BASED ON PLATE
SIZES AS NOTED:

- 1-GANG - 2.75" WIDE
- 2-GANG - 4.56" WIDE
- 3-GANG - 6.38" WIDE
- 4-GANG - 8.19" WIDE