



User Manual

HD-HPC-SP-TX / HD-HPCWP-TX

100m HDBaseT HDMI and VGA 2x1 Switcher / Extender



244 Bergen Boulevard, Woodland Park, NJ 07424 • Tel 973-785-4347 • FAX 973-785-3318 • Web: www.fsrinc.com

Important Safety Instructions

Contents are subject to change without notice

Warnings

To reduce the risk of fire, electric shock or product damage:



1. Do not expose this device to rain, moisture, dripping or splashing and that no objects filled with liquids, such as vases, shall be placed on the unit.



6. Clean this device only with dry cloth.



2. Do not install or place this unit in a bookcase, built-in cabinet or in another confined space. Ensure the unit is well ventilated.



7. Unplug this device during lightning storms or when unused for long periods of time.



3. To prevent risk of electric shock or fire hazard due to overheating, do not obstruct the unit's ventilation openings with newspapers, tablecloths, curtains, and similar items.

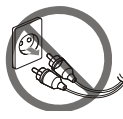

8. Protect cables and cords from being walked on or pinched particularly at plugs.



4. Do not install near any heat sources such as radiators, heat registers, stoves, or other device (including amplifiers) that produce heat.



9. Only use attachments/accessories specified by FSR.



5. Do not place sources of open flames, such as lighted candles, on the unit.



10. Refer all servicing to qualified service personnel.

Table of Contents

Overview	4
Features	5
Package Contents	6
HD-HPC-SP-Tx and HD-HPCWP-Tx sold separately	6
HD-HPC-SP-Tx	6
Typical Application	7
Typical Application	8
Dimensions	9
HD-HPCWP-Tx	9
HD-HPC-SP-Tx	9
HD-HPC-SP-Tx Front Panel	10
HD-HPCWP-Tx Front Panel	11
.....	11
HD-HPC-SP-Tx Rear Panel	12
HD-HPCWP-Tx Rear Panel	13
Hardware Installation	14
Input Select Button and switching behavior	15
Dip Switch Description	16
VGA EDID Switch Setting	16
HDMI EDID	16
SET (HD-HPC-SP-Tx only)	17
IR and RS-232 Operation	18
IR Control	18
RS-232 Control and Firmware Updates	20
Specifications	21
Limited Warranty	23

OVERVIEW

The HD-HPC-SP-Tx transmitter is a true HDBaseT 5-Play device that transmits HD Video (up to 4k at 30Hz), Audio, Bi-directional control (IR & RS-232), Ethernet, and Power via 1 CAT-6A shielded cable up to 100 Meters.

The HD-HPC-SP-Tx works with any of FSR's 100 Meter HDBaseT Receivers and can be powered from either end (Tx to Rx or Rx to Tx). The HD-HPC-SP-Tx's switcher has both HDMI and VGA with Audio.

The switcher has built-in auto-sensing circuitry to switch to the active source. It can be manually triggered using the front panel Input Select Button or via contact closure on the rear screw terminals (HD-HPC-SP-Tx only).

The HD-HPCWP-Tx is a 2-gang wallplate version of the HD-HPC-SP-Tx and fits in a standard 2-gang box.

FEATURES

- Transmission distance for 1080p over Cat 5e/6 reaches up to 100 meters. 4K reaches up to 70 meters
- Supports VGA input (with L/R audio) and HDMI input
- Switches the input source simply by pressing the button on the front panel or contact closure via pluggable screw terminal connector (HD-HPC-SP-Tx only) on the rear panel
- Automatically switches to an active source
- HDBT 2.0 compliance
- HDMI 1.4 with 4K compliance
- Bi-directional PoE (HD-HPC-SP-Tx only)
- Bi-directional IR
- IR, Ethernet and RS232 control over HDBT
- Space saving design

Note:

The actual signal transmission distance can vary and depends on signal resolution, cable quality, graphics card, and display used in the system.

PACKAGE CONTENTS

HD-HPC-SP-TX AND HD-HPCWP-TX SOLD SEPARATELY

HD-HPC-SP-TX

- One HD-HPC-SP-Tx Transmitter
- Two 2-pin screw-down terminals
- One 3-pin screw-down terminal
- One IR Emitter
- One IR Receiver (30kHz ~ 50kHz)
- Two Under Table Mounting Brackets
- User's manual

HD-HPCWP-TX

- One HD-HPCWP-TX Transmitter
- One 9-pin screw-down terminal
- Four 6-32x1/4 Flat head screws
- One cover plate and cover plate screws
- User's manual

TYPICAL APPLICATION

HD-HPC-SP-Tx shown

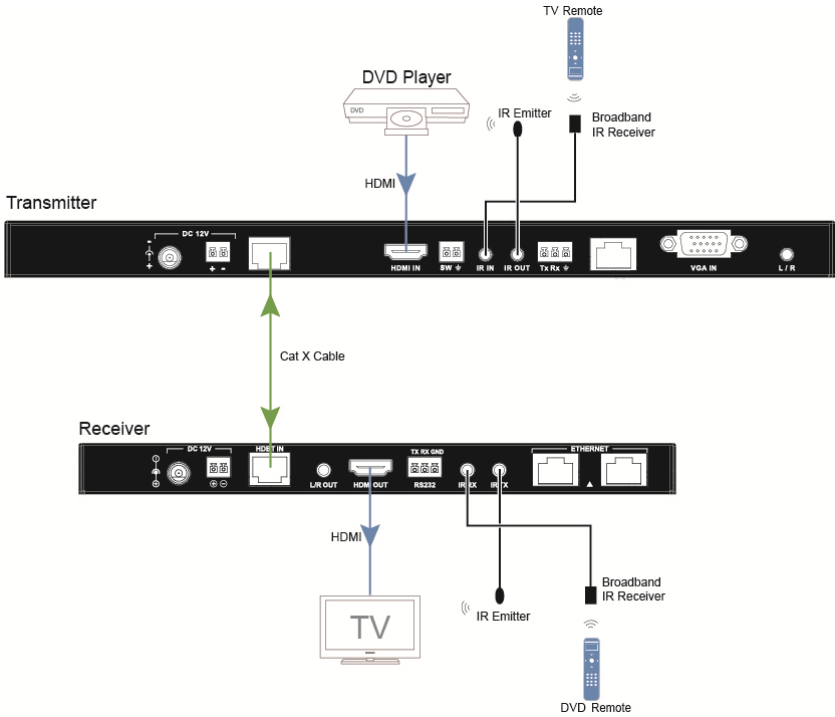

NOTE: It is only necessary to power one side (Tx or Rx)

Transmitters do not include a Power Supply. An FSR 17762 Power Supply is included with any of the FSR HDBaseT Receivers. Only one power supply is needed to power the Transmitter and Receiver set. FSR 17762 Power Supplies can also be ordered separately.

TYPICAL APPLICATION

HD-HPCWP-Tx shown

Transmitter

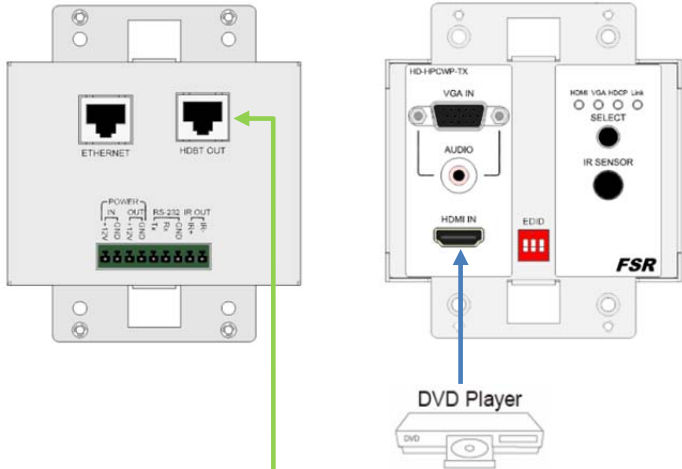

Receiver

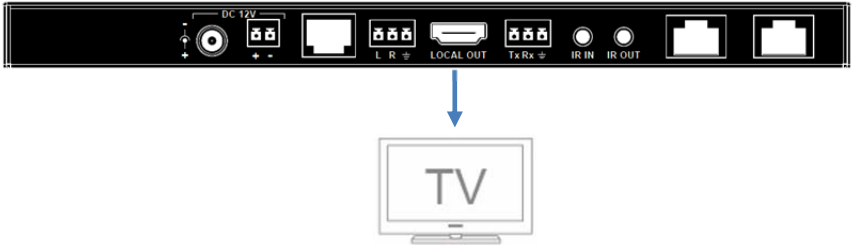

NOTE: Only one power supply is needed to power the Transmitter and Receiver set from any of the FSR's 100m HDBaseT receivers. The HD-HPCWP-Tx transmitter can be powered locally but it cannot send power to the receiver. Transmitters do not include a Power Supply. An FSR 17762 Power Supply is included with any of the FSR HDBaseT Receivers. FSR 17762 Power Supplies can also be ordered separately.

DIMENSIONS

HD-HPCWP-Tx

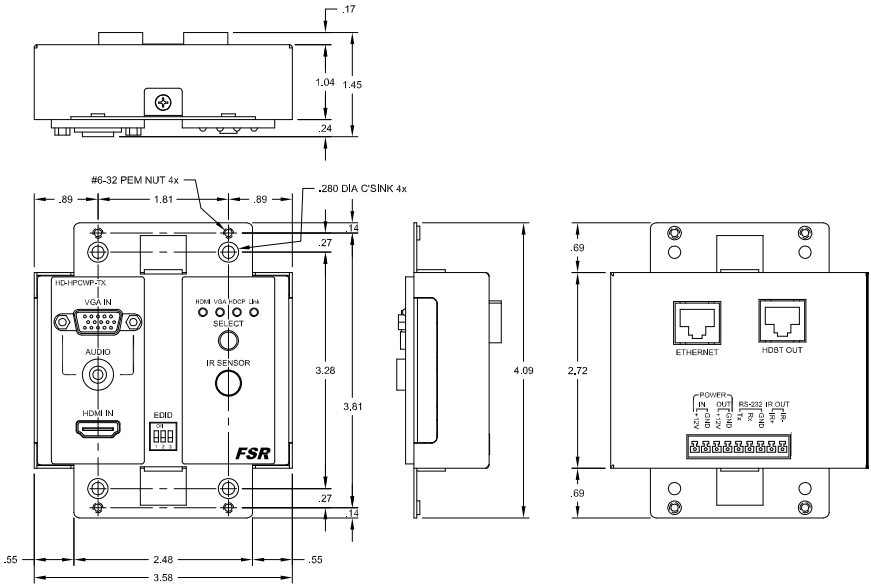

HD-HPC-SP-Tx

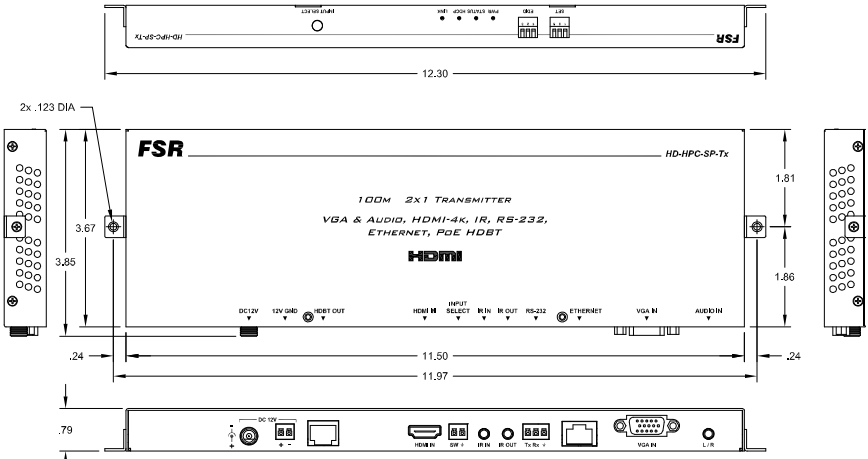

HD-HPC-SP-TX FRONT PANEL

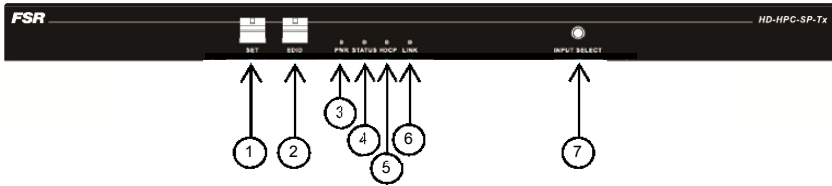

ID	Name	Description
1	SET	RS-232 Settings (See table)
2	EDID	VGA resolution settings (See table)
3	Power LED	On: Unit is powered on. Off: Unit is powered off.
4	Status LED	Intermittent: Normal operating condition Off: Fault
5	HDCP LED	On: HDCP video is being transmitted. Off/Intermittent: No HDCP video is being transmitted
6	Link LED	ON: Receiver and Transmitter are linked to each other OFF/Intermittent: Fault in unit(s) or cabling.
7	Input Select	Input select button to select the input source. The function is the same with input select (pluggable screw terminal connector) in the front panel. See "Select Button and switching behavior"

HD-HPCWP-TX FRONT PANEL

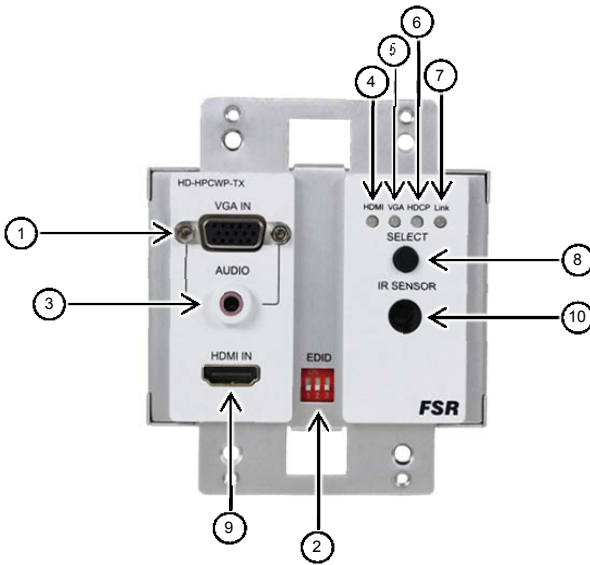

ID	Name	Description
1	VGA IN	HD-15 VGA input
2	EDID	VGA resolution settings (See table)
3	AUDIO	Stereo audio input
4	HDMI LED	Indicates HDMI input is selected
5	VGA LED	Indicates VGA input is selected
6	HDCP LED	On: HDCP video is being transmitted. Off/Intermittent: No HDCP video is being transmitted
7	Link LED	ON: Receiver and Transmitter are linked to each other OFF/Intermittent: Fault in unit(s) or cabling.
8	Input Select	Input select button used to select the input source. See "Select Button and switching behavior"
9	HDMI IN	HDMI input
10	IR SENSOR	Sensor for remote control

HD-HPC-SP-TX REAR PANEL

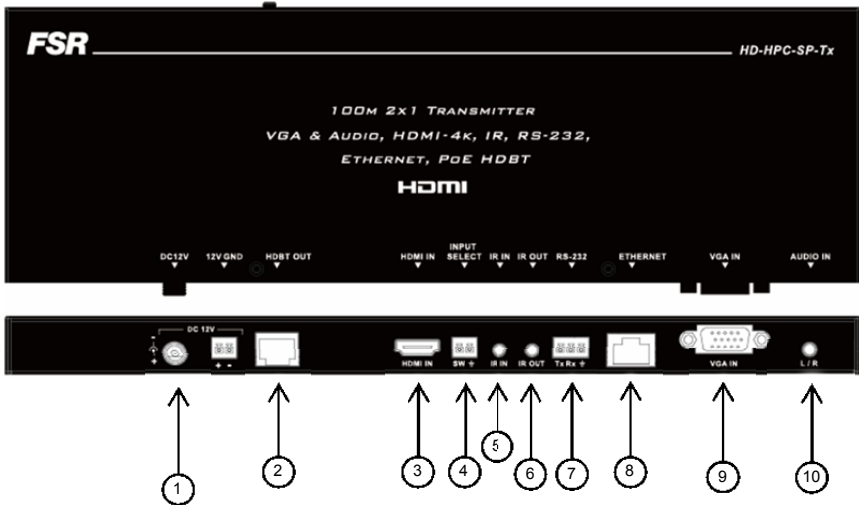

ID	Name	Description
1	Power	12V 2A DC power supply input (power supply sold separately. (See note under "Typical Application"))
2	HDBT OUT	Connects to HDBT IN port of receiver
3	HDMI IN	Connects to an HDMI source
4	Input Select	Pluggable screw terminal connector connecting to an external control pad (HD-HPC-SP-Tx only). See "Select Button and switching behavior"
5	IR IN	Connects to IR receiver
6	IR OUT	Connects to IR transmitter
7	RS-232	Serial port (See table)
8	ETHERNET	Connects to an Ethernet device
9	VGA IN	Connects to a VGA source
10	Audio IN	Audio input, embedded stereo in VGA audio

HD-HPCWP-TX REAR PANEL

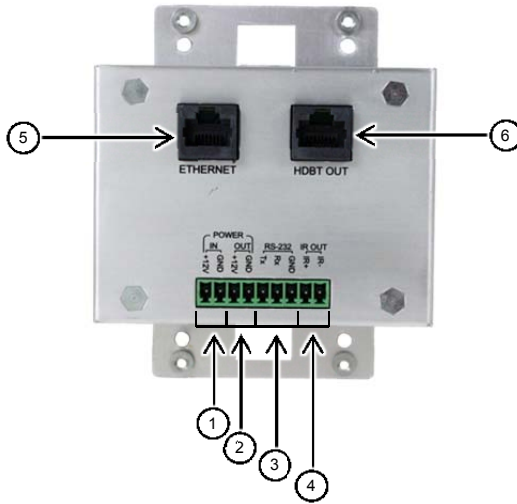

ID	Name	Description
1	POWER IN	12V 2A DC power supply input (power supply sold separately. (See note under "Typical Application"))
2	POWER OUT	12VDC 250mA max
3	RS-232	Serial port
4	IR OUT	Connects to IR transmitter
5	ETHERNET	Connects to an Ethernet device
6	HDBT OUT	Connects to HDBT IN port of receiver

HARDWARE INSTALLATION

Warnings

- Before the installation, disconnect the power supply from all the devices.
 - Do not connect or disconnect cables from the Transmitter and Receiver while they are powered ON. To connect or disconnect cables from the units, power them OFF first.
 - For best resolution and ESD performance, a shielded CAT6A in a TIA / EIA 568B wiring configuration is recommended. Please use care when installing, connecting and disconnecting cables.
1. Connect the source to the **HDMI IN** and/or **VGA IN** on the Transmitter.
 2. Connect the IR emitter to the **IR OUT** and the IR Receiver to the **IR IN** on both the Transmitter and Receiver.
 3. Connect a Display to the **HDMI OUT** on the Receiver.
 4. Connect the **HDBT OUT** on the Transmitter to the **HDBT IN** on the Receiver via a shielded CAT5e / CAT6 / CAT6A / CAT7 cable.
 5. Connect the power supply.

INPUT SELECT BUTTON AND SWITCHING BEHAVIOR

The auto switcher will select an active input or the first-come first-served if both inputs are active.

The input select switch or the contact closure (HD-HPC-SP-Tx only) can select the input type only if both inputs are active.

Key function description:

1. If HDMI IN and VGA IN are both connected to the source devices, and HDMI IN is selected as current source, pressing the input select button will switch to VGA as source. If VGA the source is unplugged, it will switch back to HDMI IN automatically.
2. If only HDMI IN is connected to the source device, and HDMI IN is selected as current source, pressing the input select button will have no effect and it will remain as HDMI IN.

DIP SWITCH DESCRIPTION

VGA EDID Switch Setting

NOTE: HD-HPC-SP-TX AND HD-HPCWP-TX HAVE OPPOSITE DIP SWITCH LOGIC FOR THE "ON" POSITION AS SHOWN BELOW:

HD-HPC-SP-TX (DOWN IS "ON")

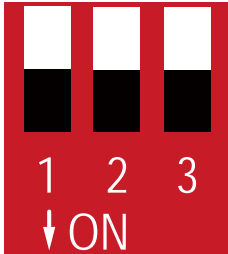

HD-HPCWP-SP-TX (DOWN IS "OFF")

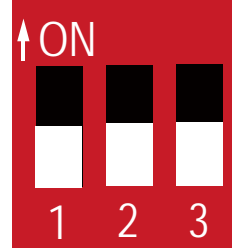

Position 1	Position 2	Position 3	Resolution
0	0	0	1280 x 800 60Hz
0	0	1	1920 x 1200 60Hz
0	1	0	1920 x 1080 60Hz (Default)
0	1	1	1280 x 720 60Hz
1	0	0	1024 x 768 60Hz
1	0	1	800 x 600 60Hz
1	1	0	Reserved
1	1	1	Reserved

0 = OFF and 1 = ON

Note:

Power cycle the extender after you change the switch position.

HDMI EDID

HD-HPC-SP-Tx: Pass-through or 1080p 60Hz if a sink is not detected.

HD-HPCWP-Tx: Pass-through

SET (HD-HPC-SP-Tx only)

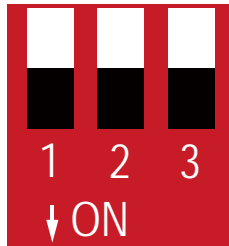

Position 1	Position 2	Position 3	Settings
0	0	0	RS-232 pass-through enabled (Default)
1	0	0	Valens IC update RS-232 pass-through disabled
0	1	0	MCU update and control RS-232 pass-through disabled

0 = OFF (UP) and 1 = ON (DOWN)

IR AND RS-232 OPERATION

(HD-HPC-SP-Tx shown)

IR Control

The IR pass-through feature on the Transmitter and Receiver allows you to control the Source from the Display's location or vice versa.

Scenario 1

The TV can be controlled from the Transmitter's location with the TV remote.

The IR receiver is connected to the IR IN on the Transmitter and the IR emitter is connected to the IR OUT on the Receiver.

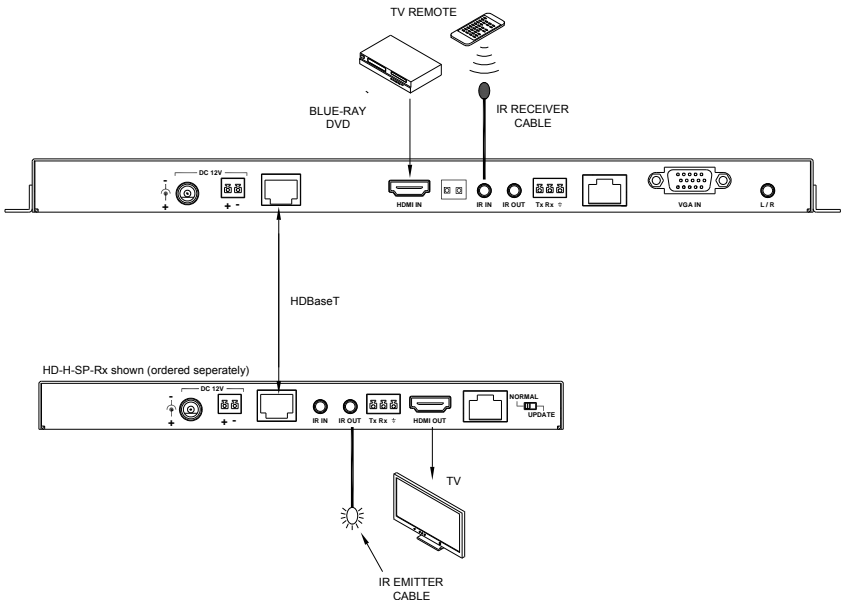

Scenario 2

The DVD Player can be controlled from the Receiver's location with the DVD Player Remote. The IR emitter is connected to the IR OUT on the Transmitter and the IR receiver is connected to the IR IN on the Receiver.

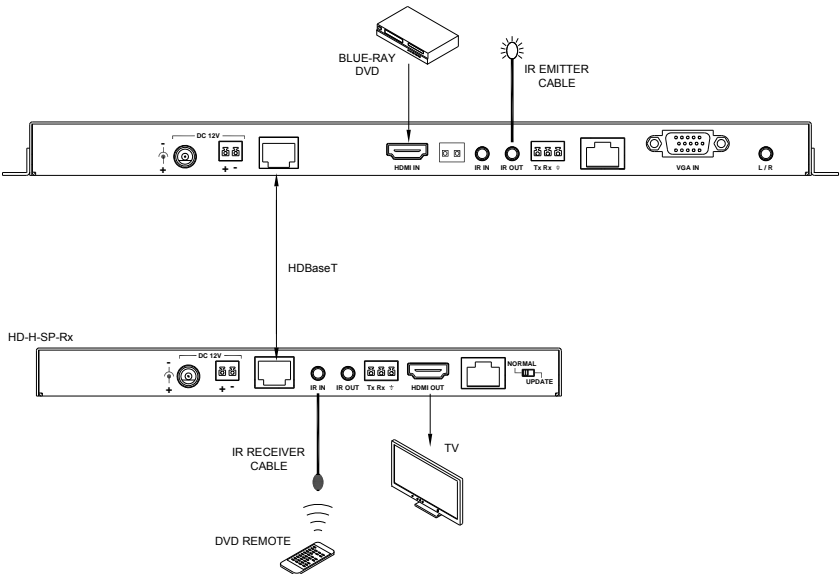

RS-232 Control and Firmware Updates

The RS-232 port can be used as a pass-through to control a device connected to the Transmitter from the Receiver or vice versa. In addition, the RS-232 port on the Transmitter can be connected to a computer to update the firmware. (See Dip switch settings)

Scenario 1: Firmware Update

(HD-HPC-SP-Tx only)

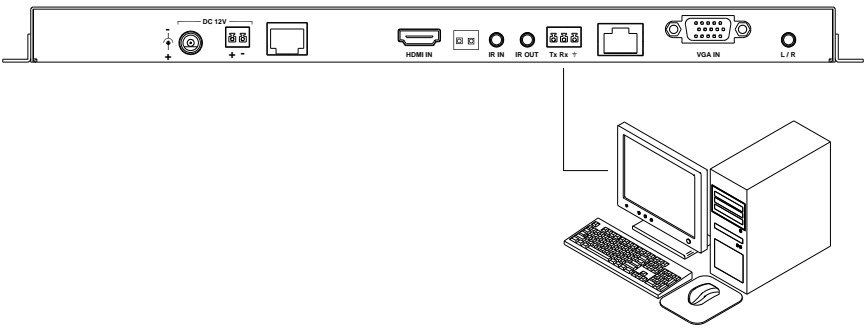

Scenario 2: RS-232 Control

Maximum baud rate is 115.2 Kbps.

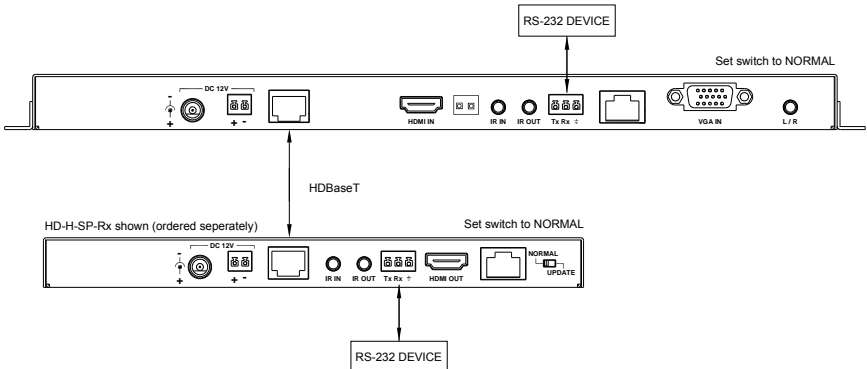

SPECIFICATIONS

Technical	
Video input Connectors	1 HDMI, 1 VGA (HD-15 female) with 1/8" Stereo
Input Signal Types	HDMI 1.4 and HDCP compliant up to 4K2K 30Hz 7.1ch audio VGA + Audio up to 1920 x 1200 60Hz.
Output	1 HDBT
Output Signal Type	HDBT
Video Impedance	100Ω
Control	
Control input	RS-232 via 3.81mm 3 Pin pluggable screw terminal Connector Switch closure via 3.81mm 3 Pin pluggable screw terminal Connector (HD-HPC-SP-Tx only) Front Panel pushbutton switch IR input and output via 1/8" jack (DV-HPC-SP-Tx) IR output via 3.81mm pluggable screw terminal
Maximum Pixel Clock	297MHz
Operating Temperature	32°F to 95°F (0°C to 35°C) 10% to 90%, non-condensing
Storage Temperature	-4°F to 140°F (-20°C to 70°C) 10% to 90%, non-condensing
Power Supply	DC 12V 2A (power supply sold separately)
ESD Protection	Human-body Model: ±8kV (Air-gap discharge) ±4kV (Contact discharge)
Surge Protection	IEC 61000-4-4 (EFT) 40A (5/50ns); IEC 61000-4-5 (Lightning) 25A (8/20μs)

Cable Specifications		
For best resolution and ESD performance Shielded CAT6A in a TIA / EIA 568B wiring configuration is recommended.		
Cable Type	Range	Supported Video
CAT5e/CAT6	100m	1080p 60Hz (36 bpp)
	70m	1080p 60Hz (48 bpp) 1080p 60Hz 3D 4K 2160p (3840x2160 30Hz)
CAT6A/CAT7	100m	1080p 60Hz (36 bpp)
		1080p 60Hz (48 bpp) 1080p 60Hz 3D 4K 2160p (3840x2160 30Hz)
General		
Shipping Weight	HD-HPCWP-Tx: 1.45 lbs. (0.66 kg) HD-HPC-SP-Tx: 2.45 lbs. (1.12 kg)	
Dimension (W x H x D)	See dimension drawings for specific model information	

LIMITED WARRANTY

The HD-HPC-SP-Tx, HD-HPCWP-SP-Tx 100m HDBaseT HDMI and VGA 2x1 Switcher / Extender are warranted against failures due to defective parts or faulty workmanship for a period of three years after delivery to the original owner. During this period, FSR will make any necessary repairs or replace the unit without charge for parts or labor. Shipping charges to the factory or repair station must be prepaid by the owner, return-shipping charges (via UPS Ground) will be paid by FSR.

This warranty applies only to the original owner and is not transferable. In addition, it does not apply to repairs done by other than the FSR factory or Authorized Repair Stations.

This warranty shall be cancelable by FSR at its sole discretion if the unit has been subjected to physical abuse or has been modified in any way without written authorization from FSR. FSR's liability under this warranty is limited to repair or replacement of the defective unit.

FSR will not be responsible for incidental or consequential damages resulting from the use or misuse of its products. Some states do not allow the exclusion of incidental or consequential damages, so the above limitations may not apply to you. This warranty gives you specific legal rights, and you may also have other rights which vary from state to state.

Warranty claims should be accompanied by a copy of the original purchase invoice showing the purchase date (if a Warranty Registration Card was mailed in at the time of purchase, this is not necessary). Before returning any equipment for repair, please read the important information on service below.

SERVICE

Before returning any equipment for repair, please be sure that it is adequately packed and cushioned against damage in shipment, and that it is insured. We suggest that you save the original packaging and use it to ship the product for servicing. Also, please enclose a note giving your name, address, phone number and a description of the problem.

NOTE: all equipment being returned for repair must have a Return authorization (RMA) Number. To get a RMA Number, please call the FSR Service Department (1-800-332-FSR1).

Please display your RMA Number prominently on the front of all packages.

CONTACT INFORMATION:

FSR INC.

244 Bergen Blvd.

Woodland Park, NJ 07424

Phone: (973) 785-4347

Order Desk Fax: (973) 785-4207

Web Site: <http://www.fsrinc.com>