

NOTE: 5.50 MAX (WITH PROVIDED ADJUSTMENT SCREWS OR 6.00 MAX WITH USER SUPPLIED THREADED ROD) AND 3.25 MIN ADJUSTMENT RANGE.

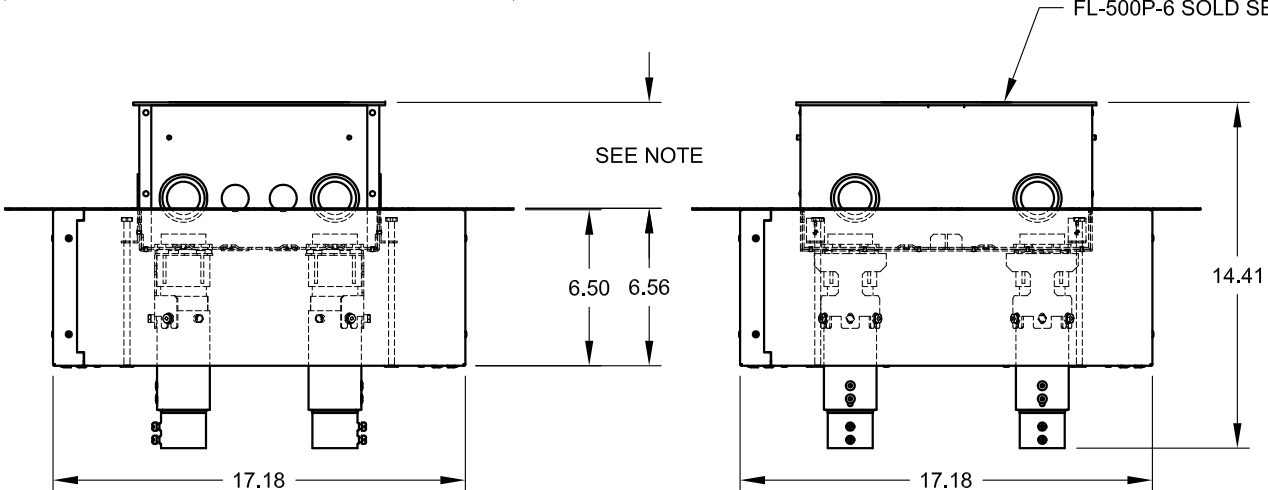

**FSR inc.**  
 244 BERGEN BLVD.  
 WOODLAND PARK, NJ 07424  
 TEL (973) 785-4347  
 FAX (973) 785-3318

TITLE: FL-FRK-500P		
DRAWN BY: JRE	DATE: 02/16/16	REV: 04
DWG#: FL-FRK-500P	PAGE: 1 OF 2	SCALE: -

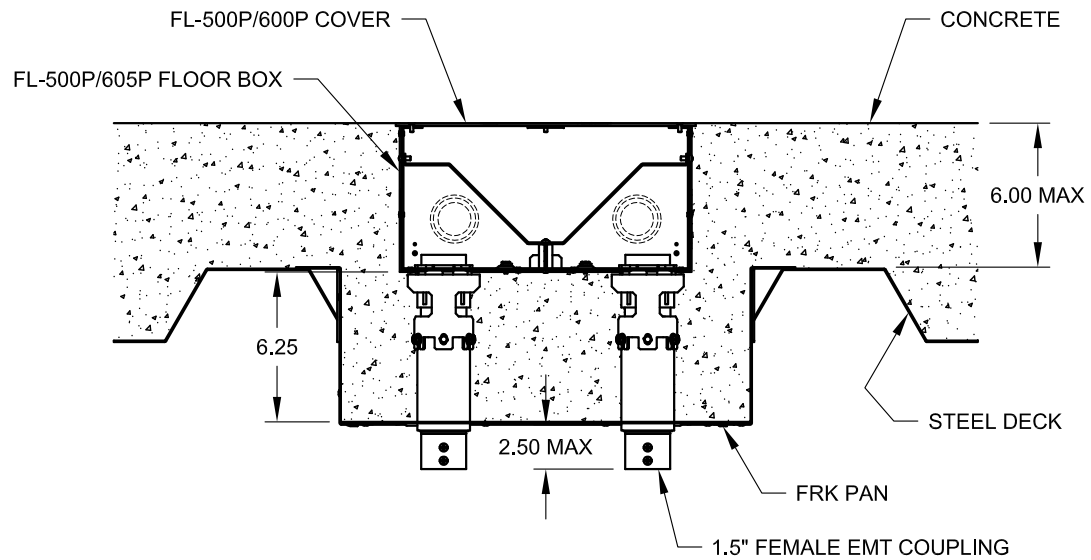
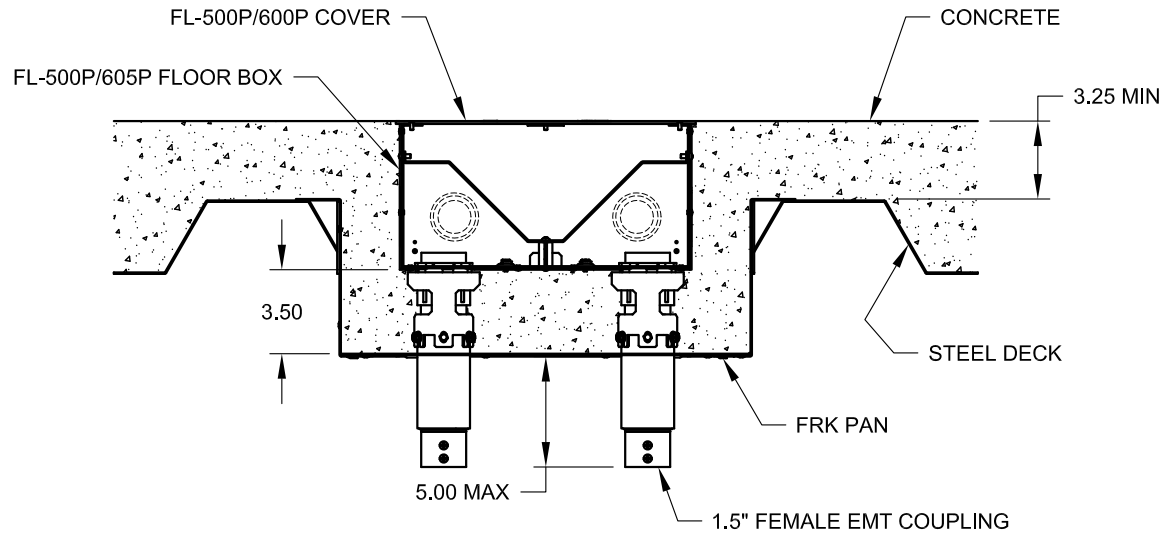

**FSR inc.**  
 244 BERGEN BLVD.  
 WOODLAND PARK, NJ 07424  
 TEL (973) 785-4347  
 FAX (973) 785-3318

TITLE:		
FL-FRK-500P/605P		
DRAWN BY: JRE	DATE: 02/16/16	REV: 04
DWG#: FL-FRK-500P	PAGE: 2 OF 2	SCALE: -