

4

3

2

1

C

C

B

B

A

A

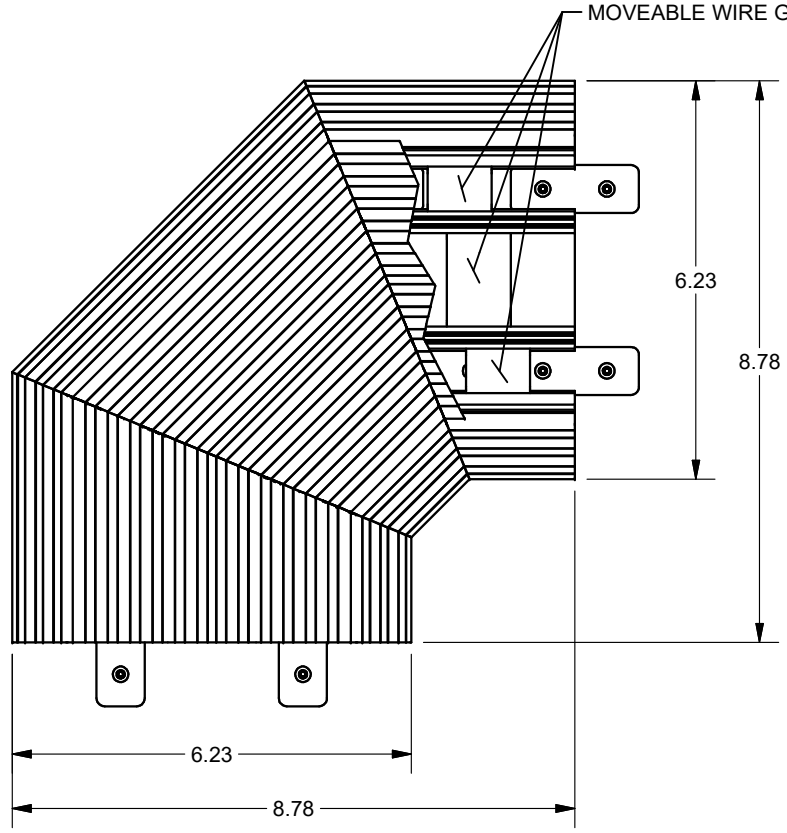

CENTER SECTION CAN BE LEFT OUT FOR CONSTRUCTING A 45 DEGREE ELBOW

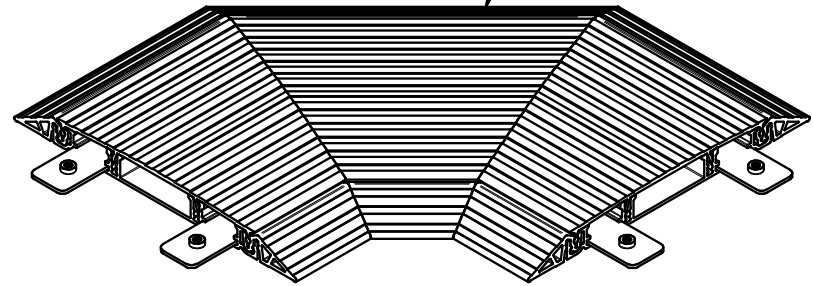

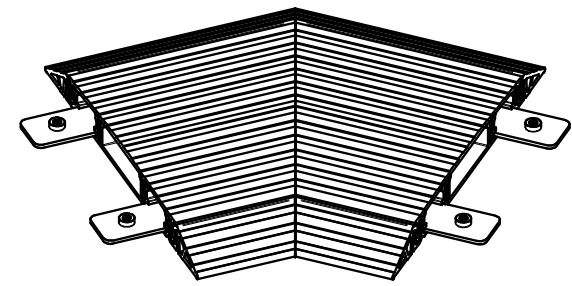

90 DEGREE ELBOW

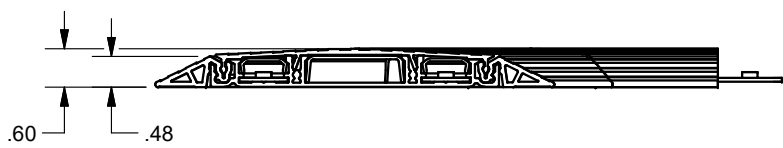

45 DEGREE ELBOW



EDGE TYPE	BASE WIDTH	WITH EDGE
 EDGE #1	4.50	6.23
 EDGE #2	4.50	5.36
 EDGE #3	4.50	4.50

ADA COMPLIANT

FSR inc. <small>244 BERGEN BLVD. WOODLAND PARK, NJ 07424 TEL (973) 785-4347 FAX (973) 785-3318</small>	TITLE: SW-L90		
	DRAWN BY: JRE	DATE: 10/24/24	REV: 01
	DWG#:	SW-L90	SCALE: -

4

3

2

1